

**UNI-T®**

**Model UT804  
OPERATING MANUAL**

## Table of Contents

Chapter	Title	Page
1.	<b>Before You Start</b> .....	6
	Overview .....	6
	Unpacking Inspection .....	7
	Safety Information .....	8
	Rules For Safe Operation .....	8
	International Electrical Symbols .....	10
2.	<b>Getting Acquainted</b> .....	11
	Turning the Meter On .....	11
	Battery Considerations .....	11
	Automatic Power Off .....	11
	Automatic Backlight Off .....	11
	Low Battery Indication .....	12
	The Meter Structure .....	12
	Rotary Switch .....	13
	Functional Buttons .....	15
	The Meter Functions Vs Displays .....	18
	Selecting the Range .....	20
	Understanding the Display .....	20
	Analogue Bar Graph .....	24
	Using MAX MIN .....	24
3.	<b>Making Measurements</b> .....	25
	A.Measuring DC Voltage .....	25
	B.Measuring AC Voltage .....	27

### Table of Contents

Chapter	Title	Page
	C.Measuring DC Millivoltage .....	28
	D.Measuring Currents .....	29
	E.Measuring Resistance .....	35
	F.Testing for Continuity .....	37
	G.Testing Diodes .....	38
	H.Measuring Capacitance .....	40
	I. Measuring Frequency / Duty Cycle .....	42
	J.Measuring Temperature .....	43
	K.4~20mA loop current as % readout .....	44
<b>4.</b>	<b>Using Stores, Recall and Send Features</b> .....	<b>46</b>
	Introduction .....	46
	Storing and Clearing Readings .....	46
	Recalling Stored Readings .....	47
	Using Send .....	47
<b>5.</b>	<b>Changing the Default Setting</b> .....	<b>48</b>
	Introduction .....	48
	Selecting Setup Options .....	48
	Saving Setup Options .....	50
<b>6.</b>	<b>Maintenance</b> .....	<b>51</b>
	A.General Service .....	51
	B.Replacing the Fuses .....	51
	C.Replacing the Battery .....	53

## Table of Contents

Chapter	Title	Page
7.	<b>Specifications</b> .....	54
	Safety and Compliances .....	54
	Physical Specifications .....	55
	General Specifications .....	56
	Feature Summary .....	56
	Basic Specifications .....	57
	Detailed Accuracy Specifications .....	58
	A. DC Voltage .....	58
	B. AC Voltage .....	59
	C. DC Current .....	60
	D. AC Current .....	61
	E. Resistance .....	62
	F. Continuity Test .....	62
	G. Diode Test .....	63
	H. Capacitance .....	63
	I. Frequency .....	64
	J. Duty Cycle .....	65
	K. Temperature .....	65
	1-1. Degrees Celsius .....	65
	1-2. Fahrenheit .....	66
	L. 4~20mA loop current .....	67

		<b>List of Tables</b>
<b>Table</b>	<b>Title</b>	<b>Page</b>
1-1	Unpacking Inspection .....	7
1-2	International Electrical Symbols .....	10
2-1	Rotary Switch Selections .....	14
2-2	Functional Buttons .....	15
2-3	Functions Vs Displays .....	18
2-4	Display Features .....	21
5-1	Setup Selections .....	49

**List of Tables**

<b>Table</b>	<b>Title</b>	<b>Page</b>
2-1	Meter Structure -----	12
2-2	Display Features -----	20
3-1	DC Voltage Measurement -----	25
3-2	AC Voltage Measurement -----	27
3-3	DC Millivoltage Measurement -----	28
3-4	DC $\mu$ A Currents Measurement -----	29
3-5	AC $\mu$ A Currents Measurement -----	30
3-6	DCmA Currents Measurement -----	31
3-7	ACmA Currents Measurement -----	32
3-8	DCA Currents Measurement -----	33
3-9	ACA Currents Measurement -----	34
3-10	Resistance Measurement -----	35
3-11	Continuity Test -----	37
3-12	Diode Test -----	38
3-13	Capacitance Measurement -----	40
3-14	Frequency / Duty Cycle Measurement -----	42
3-15	Temperature Measurement -----	43
3-16	4~20mA loop current as % readout -----	44
6-1	Fuse Replacement -----	51
6-2	Battery Replacement -----	53

## Chapter 1 Before You Start

### Overview

This Operating Manual covers information on safety and cautions. Please read the relevant information carefully and observe all the **Warnings** and **Notes** strictly.



### Warning

**To avoid electric shock or personal injury, read the “Safety Information” and “Rules for Safe Operation” carefully before using the Meter.**

Bench Type Digital Multimeter **UT804** (hereafter referred to as “the Meter”) is a 40000 counts and 4 3/4 digits with steady operations, fashionable structure and auto ranging instrument. It not only can measure AC voltage and current, DC voltage and current, Resistance, Capacitance, Temperature, Frequency, Diodes, Continuity, 4~20mA Loop, Max/Min, Relative Mode but also has Setup, Data Store, Data Recall, AC True RMS or AC+DC Voltage and Current, Low Battery Display,

White Colour Display Backlight, Data Hold, Automatic Power Off and full overload protection.

## Unpacking Inspection

Open the package case and take out the Meter. Check the items shown on Table 1-1 carefully to see any missing or damaged part:

Table 1-1. Unpacking Inspection

Item	Description	Qty
1	English Operating Manual	1 piece
2	Test Lead	1 pair
3	K-Type (nickel chromium ~ nickel silicon) Point Contact Temperature Probe (It is only suitable for measuring temperature under 230°C)	1 piece
4	Alligator Clip	1 piece
5	Test Clip	1 pair
6	USB interface cable	1 piece
7	RS232C interface cable	1 piece
8	CD-ROM (Installation Guide & Computer Interface Software)	1 piece
9	1.5V Battery (R14)	6 pieces
10	AC110V/50Hz Power Cable	1 piece

In the event you find any missing or damage, please contact your dealer immediately.



### Safety Information

This Meter complies with the standards IEC61010 safety measurement requirement: in pollution degree 2, overvoltage category (CAT. I 1000V, CAT.II 600V) and double insulation.

CAT. I: Signal level, special equipment or parts of equipment, telecommunication, electronic, etc., with smaller transient overvoltages than overvoltages CAT. II.

CAT. II: Local level, appliance, PORTABLE EQUIPMENT etc., with smaller transient voltage overvoltages than CAT. III

Use the Meter only as specified in this operating manual, otherwise the protection provided by the Meter may be impaired.

In this manual, a **Warning** identifies conditions and actions that may pose hazards to the user, or may damage the Meter or the equipment under test.

A **Note** identifies the information that user should pay attention to.

International electrical symbols used on the Meter and in this Operating Manual are explained on page 8.

### Rules For Safe Operation

#### **Warning**

**To avoid possible electric shock or personal injury, and to avoid possible damage to the Meter or to the equipment under test, adhere to the following rules:**

- 1 **Before using the Meter inspect the case. Do not use the Meter if it is damaged or the case (or part of the case) is removed. Look for cracks or missing plastic.**
- 1 **Inspect the test leads for damaged insulation or exposed metal. Check the test leads for continuity. Replace damaged test leads with identical model number or electrical specifications before using the Meter.**
- 1 **Do not apply more than the rated voltage or current, as marked on the Meter, between the**

- terminals or between any terminal and grounding.
- 1 The rotary switch should be placed in the right position and no any changeover of range shall be made during measurement is conducted to prevent damage of the Meter. Must disconnect the connection between the test leads and the tested circuit before changing the measurement position of the rotary switch.
  - 1 During measurement, do not contact naked wire, connector, un-used input terminal or the circuit in used.
  - 1 When the Meter working at an effective voltage over 60V in DC or 30V in AC, special care should be taken for there is danger of electric shock.
  - 1 Use the proper terminals, function, and range for your measurements.
  - 1 If the value to be measured is unknown, use the maximum measurement position.
  - 1 Do not use or store the Meter in an environment of high temperature, humidity, explosive, inflammable and strong magnetic field. The performance of the Meter may deteriorate after dampened.
- 1 When using the test leads, keep your fingers behind the finger guards.
  - 1 Disconnect circuit power and discharge all high-voltage capacitors before testing resistance, continuity and diodes.
  - 1 Before measuring current, check the Meter's fuses and turn off power to the circuit before connecting the Meter to the circuit.
  - 1 When under battery operated situation, replace the battery as soon as the battery indicator  appears. With a low battery, the Meter might produce false readings that can lead to electric shock and personal injury.
  - 1 When servicing the Meter, use only the same model number or identical electrical specifications replacement parts.
  - 1 The internal circuit of the Meter shall not be altered at will to avoid damage of the Meter and any accident.
  - 1 Soft cloth and mild detergent should be used to clean the surface of the Meter when servicing. No abrasive and solvent should be used to prevent the surface of the Meter from corrosion, damage







and accident.

- 1 **The Meter is suitable for indoor use.**
- 1 **When under battery operated situation, turn the Meter off when it is not in use and take out the battery when not using for a long time.**
- 1 **When under battery operated situation, constantly check the battery as it may leak when it has been using for some time, replace the battery as soon as leaking appears. A leaking battery will damage the Meter.**
- 1 **Under the influence of Radiated Radio-Frequency Electromagnetic Field & Conducted Radio-Frequency Electromagnetic Field phenomenon, the captioned model have a magnificent error in temperature measurement, it will be back to normal when the interference is removed.**

### International Electrical Symbols

Symbols used on the Meter and in this manual are explained in Table1-2.

Table 1-2. International Electrical Symbols

	AC or DC
	DC Measurement
	AC Measurement
	Grounding
	Warning. Refer to the Operating Manual
	Deficiency of Built-In Battery
	Conforms to Standards of European Union

## Chapter 2 Getting Acquainted

### Turning the Meter On

To turn the Meter on, switch on the on-off switch at the back of the Meter.

### Battery Considerations

The Meter uses one 6pcs X 1.5V Battery (R14) or AC110V 50Hz. The following paragraphs describe several techniques used to conserve battery power.

### Automatic Power Off

Under battery operated situation, the display blanks and the Meter goes into a “sleep” mode if you have not changed the rotary switch position or pressed a button for a set period. While in Sleep mode, pressing the **EXIT** button or turning the rotary switch could turn the Meter on. The Meter then returns to the display for the function selected with the rotary switch; all previously activated button features are discarded.

The automatic power off is preset to 10 minutes. From the Setup menu (see Chapter 5), you could specify a time (10 minutes, 20 minutes, 30 minutes or OFF). If you set to OFF, the Meter retains on until you turn the rotary switch to OFF or the battery becomes too weak.

Under AC operated situation, the automatic power off feature is invalid.

### Automatic Backlight Off

Under battery operated situation, AC Press and hold **LIGHT** button for around 1 second to turn the backlight on. Press **EXIT** to exit the feature

In Setup menu (see Chapter 5), you could specify a time to automatically turn off the backlight (10 seconds, 20 seconds, 30 seconds or OFF). If the period is set to OFF, the backlight feature is disabled.

Under AC operated situation, the backlight is always on, cannot turn off.

### Low Battery Indication

A constant battery icon (  ) in the middle left area of the display notifies you that the batteries are low and should be replaced.

### Warning

To avoid false readings, which could lead to possible electric shock or personal injury, replace the battery as soon as the battery icon (  ) appears.

### The Meter Structure

The Figure 2-1 shows the Meter structure.

1. LCD Display
2. Functional Buttons
3. Rotary Switch
4. Input Terminals

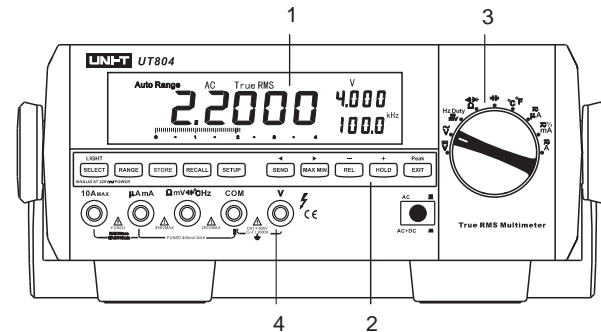

Figure 2-1. Meter Structure

### Rotary Switch









Turn the Meter on by selecting any measurement function. The Meter presents a standard display for that function. The display may also be influenced by some of the choices made in Setup.

Use the blue **SELECT** button to select any rotary switch alternate function (labeled in blue letters).

When you turn the rotary switch from one function to another, a display for the new function appears. Button choices made in one function do not carry over into another function.

The Table 2-1 described each rotary switch position

Table 2-1. Rotary Switch Selections

Rotary Switch Position	Rotary Switch Function	Blue SELECT Function
	DC voltage measurement	None
	AC voltage measurement	None
Hz Duty mV 	DC millivoltage measurement	I Frequency measurements I Duty Cycle measurement
	Resistance measurement	I Diode test I Continuity test
	Capacitance measurement	None
°C °F	Centigrade temperature measurement	Fahrenheit temperature measurement
	AC or DC current measurement (400μA , 4000μA)	Toggle between AC or DC current
	AC or DC current measurement (40mA , 400mA)	Toggle between AC or DC current 4~20mA loop current as % reading
	AC or DC current measurement (10A)	Toggle between AC or DC current

### Functional Buttons

The buttons activate features that augment the function selected with the rotary switch. The buttons are shown in Table 2-2.

Table 2-2. Functional Buttons





Button	Description	Access Method
	<b>SELECT</b> feature: Use the blue button to select any rotary switch alternate function (labeled in blue letters)	Press the button once.
	<b>LIGHT</b> feature: Under battery operated situation, turn the display backlight on. Under AC operated situation, the backlight is always on, cannot turn off.	Press and hold the button for around 1 second.
	Exit AUTO and enter MANUAL ranging. In MANUAL, select next input range. Press <b>EXIT</b> to return to AUTO. AUTO is default.	Press the button once.
	Store the current measurement value. Press <b>EXIT</b> to exit the Store feature.	Press the button once.
	Recall the stored value. Press <b>EXIT</b> to exit the Recall feature.	Press the button once.
	Access Setup selections, the display shows "SET" flashing In the Setup mode, each press of <b>SETUP</b> button steps to the next Selection	Press the button once.



Table 2-2. Functional Buttons







Button	Description	Access Method
	<p>Press to output the data, AUTO mode switch off. The primary display shows "SEND". Press <b>EXIT</b> to exit.</p>	Press the button once
	<p>Setup feature: In Setup, press to select OFF at the selection of HIGH and LOW</p>	Press the button once after entering Setup mode.
	<p>Press to display max, min and current measurement reading. Press <b>EXIT</b> to stop and return to current measurement mode.</p>	Press the button once.
	<ul style="list-style-type: none"> <li>  In Setup, each press to select the digit you want to edit.</li> <li>  In Recall, press to enable SEND feature</li> <li>  In Store, press to toggle between clearing all the stored reading or start storing reading from the current index number.</li> </ul>	Press the button once after entering Setup or Recall or Store mode.
	<p>Press to enter relative mode, the primary display shows <math>\Delta</math>. The upper right secondary display shows the present measurement value. The lower right secondary display shows the stored value. The primary display shows the present measurement value minus the stored value. Press <b>EXIT</b> to exit relative mode.</p>	Press the button once.

Table 2-2. Functional Buttons

Button	Description	Access Method
	In Setup, each press to decrement an Option. In Recall, each press to go back to the previous stored reading. In Store, each press to decrease a second on the storing interval. Press <b>EXIT</b> to exit	Press the button once after entering Setup or Recall or Store mode.
	Hold feature: Press <b>HOLD</b> to freeze the displayed value. Press <b>EXIT</b> to release the display.	Press the button once.
	In Setup, each press to increment an Option. In Recall, each press to recall the next stored reading. In Store, each press to increase a second on the storing interval.	Press the button once after entering Setup or Recall or Store mode.
	Press to exit certain button functions and the Meter will return to the factory default setting.	Press the button once.
	Peak feature: Press to access Peak Hold feature, the primary display shows the peak hold reading. The Meter can measure around as low as pulse 10μS peak signal. The Meter shows "Peak.". Press <b>EXIT</b> to exit.	Press and hold the button for over 1 second.
	When it is at AC measurement mode, press the button to display AC+DC True RMS value and "AC+DC".	Press the button down

### The Meter Functions Vs Displays

Table 2-3 shows the cross reference of function and display:

Table 2-3 Functions Vs Displays

Function	Primary Display	Lower Right Secondary Display	Upper Right Secondary Display
<b>DCV</b>	The tested DC voltage value	No display	Full range: 4, 40, 400, 1000
<b>ACV</b>	The tested AC voltage value	The tested frequency value: 40.00kHz~ 250.0kHz	Full range: 4, 40, 400, 750
<b>DCmV</b>	The tested DCmV value	No display	Full range 400
$\Omega$	The tested resistance value	No display	Full range: 400, 4, 40, 400, 4, 40
$\bullet\text{)}\text{)}$	The tested resistance value	No display	Full range value: 400
$\rightarrow\text{+}$	The tested resistance value	No display	Full range 4
<b>Hz</b>	The tested frequency value	No display	Full range: 40, 400, 4, 40, 400, 4, 40, 400
$\text{+}$	The tested capacitance value	No display	Full range: 40, 400, 4, 40, 400, 4, 40
$^{\circ}\text{C}$	The tested $^{\circ}\text{C}$ value	No display	1000
$^{\circ}\text{F}$	The tested $^{\circ}\text{F}$ value	No display	1832
<b>DC<math>\mu</math>A</b>	The tested DC $\mu$ A value	N/A	Full range: 400, 4000
<b>AC<math>\mu</math>A</b>	The tested AC $\mu$ A value	The tested frequency value: 40.00kHz~100.0kHz	Full range: 400, 4000
<b>DCmA</b>	The tested DCmA value	No display	Full range: 40, 400

Table 2-3 Functions Vs Displays

Function	Primary Display	Lower Right Secondary Display	Upper Right Secondary Display
<b>ACmA</b>	The tested ACmA value	The tested frequency value: 40.00kHz~100.0kHz	Full range: 400, 4000
<b>DCA</b>	The tested DC current value	No display	Full range: 10
<b>ACA</b>	The tested AC current value	The tested frequency value: 40.00kHz~100.0kHz	Full range: 10
<b>STORE</b>	The current measurement reading	The value of the corresponding index number	Index number increase one. Index number: no.0001~no.9999
<b>RECALL</b>	The recalled value	The total number of stored value.	Index number: no.0001~no.9999
<b>MAX MIN</b>	Chapter 2 Getting Acquainted – Using MAX MIN		
<b>REL</b> Δ	The present measurement value minus the stored value	The stored value	The present measurement value.

### Selecting the Range

Press **RANGE** to enter manual ranging mode and select a fixed range.

Autoranging (AUTO lighted in the display) always comes on initially when you select a new function. In autorange, the Meter selects the lowest input range possible, ensuring that the reading appears with the highest available resolution.

If AUTO is already on, press **RANGE** to enter MANUAL ranging in the present range. You can then select the next manual range each time you press **RANGE**. Return to autoranging by press **EXIT**.

Press **RANGE** when turning on the Meter, the Meter enters the analogue resistance signal measurement mode.

### Understanding the Display

Display features are shown in Figure 2-2 and described in Table 2-4.

Figure 2-2. Display Features

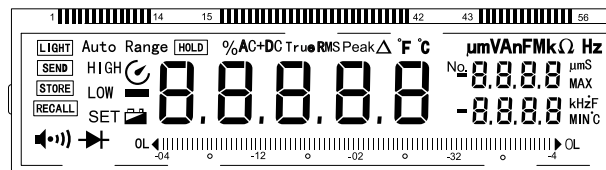

Table 2-4. Display Features



No.	Symbol	Meaning
1	<b>MAX</b>	Maximum reading displayed.
	<b>MIN</b>	Minimum reading displayed
2	<b>No</b>	The sequence of the reading.
3	<b>°C °F</b>	Degrees Celsius (default) or Fahrenheit.
4	<b>HμmS</b>	H: Hour μ: Micro m: Minutes (Milli) S: Second
5		Indicates negative reading
6		The battery is low. Warning: To avoid false readings, which could lead to possible electric shock or personal injury, replace the battery as soon as the battery indicator appears.
7	<b>SET</b>	Setup feature is on.
8	<b>AC+DC</b>	For DCV and DCA functions, reading represents the True RMS total of AC and DC measurements
9	<b>TrueRMS</b>	Indicator for True RMS value.

Table 2-4. Display Features

No.	Symbol	Meaning
10	$\Omega$ , k $\Omega$ , M $\Omega$	$\Omega$ : Ohm. The unit of resistance. k $\Omega$ : Kiloohm. $1 \times 10^3$ or 1000 ohms M $\Omega$ : Megaohm. $1 \times 10^6$ or 1,000,000 ohms
	Hz, kHz, MHz	Hz : Hertz. The unit of frequency in cycles/second. kHz: Kilohertz. $1 \times 10^3$ or 1000 hertz MHz: Megahertz, $1 \times 10^6$ or 1,000,000 hertz.
	mV, V	V: Volts. The unit of voltage. mV: Millivolt. $1 \times 10^{-3}$ or 0.001 volts
	$\mu$ A, mA, A	A: Amperes (amps). The unit of current. mA: Milliamp, $1 \times 10^{-3}$ or 0.001 amperes. $\mu$ A: Microamp. $1 \times 10^{-6}$ or 0.000001 amperes.
	nF, $\mu$ F, mF	Farad. The unit of capacitance nF: Nanofarad. $1 \times 10^{-9}$ or 0.000000001 farads. $\mu$ F: Microfarad. $1 \times 10^{-6}$ or 0.000001 farads. mF: Millifarad. $1 \times 10^{-3}$ or 0.001 farads.
11		Automatic power off feature is on

Table 2-4. Display Features

No.	Symbol	Meaning
12	• )	Continuity test
13	<b>STO</b>	Data store is on
	<b>RCL</b>	Data recall is on
14	△	The relative mode is on to display the present value minus the stored value.
15	<b>LOW</b>	The indicator for the lowest setup limit.
16	<b>AUTO</b>	The Meter is in the auto range mode in which the Meter automatically selects the range with the best resolution.
17	<b>SEND</b>	Data output is in progress
18	☀	Backlight feature is on
19	<b>HOLD</b>	Data hold mode is active
20	<b>PEAK HOLD</b>	Peak hold mode is active
21	→ ←	Diode test
22	%	l Frequency signal duty cycle.
		l 4~20mA loop current as % reading
23	▶ <b>OL</b>	The input value is too large for the selected range.
24	<b>Analogue Bar Graph</b>	Provides an analog indication of the present input, quick response.



### **Analogue Bar Graph**

The bar graph provides an analogue indication of the measured input. For most measurement functions, the bar graph updates 10 times per second.

### **Using MAX MIN**

The MAX MIN mode stores minimum (MIN) and maximum (MAX) input values. When the input goes below the stored minimum value or above the stored maximum value, the Meter beeps and stores the new value.

Press **MAX MIN** to enter MAX MIN mode. The sampling time is every 2 seconds. The maximum reading and MAX are shown on the upper right secondary display. The minimum reading and MIN are shown on the lower right secondary display. The primary display shows the current measurement reading.

To exit MAX MIN mode, press **EXIT**.

Press **HOLD** to stop the Meter updating reading.

MAX MIN mode can only be used under MANUAL ranging mode. Under frequency and duty cycle measurement mode, MAX MIN mode is invalid.

### Chapter 3 Making Measurement

#### Introduction

Chapter 3 explains how to make measurements. Most measurement functions can be selected by using the rotary switch.

While letters or symbols identify primary functions; blue letters or symbols identify alternative functions. Press the **BLUE** button to access these alternate functions.

#### A. Measuring DC Voltage

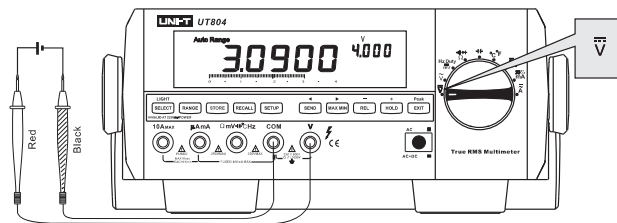

Figure 3-1. DC Voltage Measurement

#### ⚠ Warning

To avoid harms to you or damages to the Meter from electric shock, please do not attempt to measure voltages higher than 1000V, although readings may be obtained.

To measure DC voltage, set up the Meter as Figure 3-1 and do the following:

1. Insert the red test lead into the **V** terminal and the black test lead into the **COM** terminal.
2. Set the rotary switch to  $\overline{V}$ .
3. Connect the test leads across with the object being measured.
4. The measured value shows on the display. It displays the RMS.

### Note

- 1 When measuring  $\bar{v}$ , the Meter acts around a  $10M\Omega$  input impedance in parallel with the circuit. This loading effect can cause measurement errors in high impedance circuits. In most cases, the error is negligible (0.1% or less) if the circuit impedance is  $10k\Omega$  or less.
- 1 Special care should be taken when measuring high voltage.
- 1 When voltage measurement has been completed, disconnect the connection between the testing leads and the circuit under test and remove testing leads away from the input terminals of the Meter.

## Model UT804: OPERATING MANUAL

### B. Measuring AC Voltage

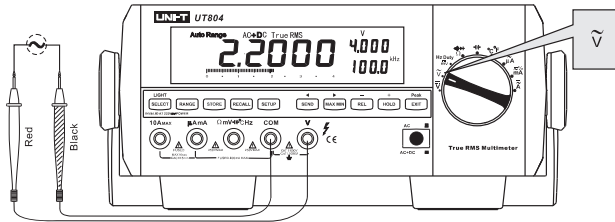

Figure 3-2. AC Voltage Measurement

#### Warning

To avoid harms to you or damages to the Meter from electric shock, please do not attempt to measure voltages higher than 1000V, although readings may be obtained.

To measure AC voltage, set up the Meter as Figure 3-2 and do the following:

1. Insert the red test lead into the **V** terminal and the black test lead into the **COM** terminal.
2. Set the rotary switch to  $\tilde{V}$ .
3. Connect the test leads across with the object being measured.
4. The measured value shows on the display. It displays the True RMS value.

When a ACV function is selected, you can press the **AC+DC button** to view the AC + DC True RMS value in the primary display. To exit, please **EXIT** button.

#### Note

- 1 When measuring  $\tilde{V}$ , the Meter acts around a 10M $\Omega$  input impedance in parallel with the circuit. This loading effect can cause measurement errors in high impedance circuits. In most cases, the error is negligible (0.1% or less) if the circuit impedance is 10k $\Omega$  or less.
- 1 Special care should be taken when measuring high voltage.
- 1 When voltage measurement has been completed, disconnect the connection between the testing leads and the circuit under test and remove testing leads away from the input terminals of the Meter.



## Model UT804: OPERATING MANUAL

### D. Measuring Currents

#### DC $\mu$ A range measurement

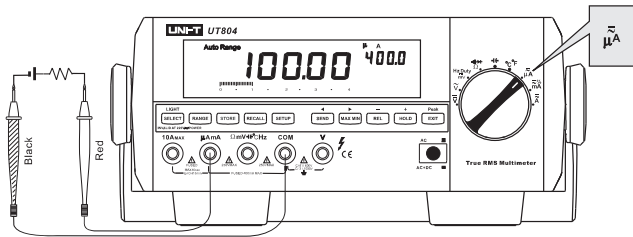



Figure 3-4. DC $\mu$ A Currents Measurement

#### **Warning**

If the fuse burns out during measurement, the Meter may be damaged or the operator himself may be hurt.

To avoid possible damage to the Meter or to the equipment under test, check the Meter's fuses before measuring current. Use proper terminals, function, and range for the measurement. Never place the testing leads in parallel with any circuit or component when the leads are plugged into the current terminals.

To measure DC $\mu$ A current, set up the Meter as Figure 3-4 and proceed as follows:

1. Insert the red test lead into the  $\mu$ **AmA** terminal and black test lead into the **COM** terminal.
2. Set the rotary switch to  $\mu$ **A** . DC measurement is default, or press **SELECT** button to select DC measurement mode.
3. Connect the test leads in serial with the object being measured.  
The measured value shows on the display. It displays the RMS.

### AC $\mu$ A range measurement

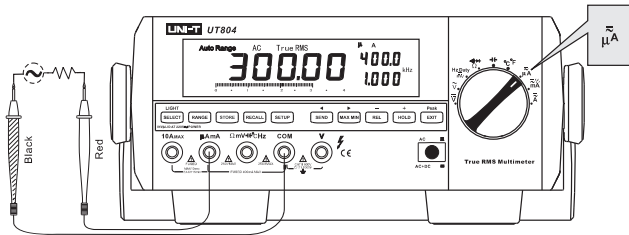

Figure 3-5. AC $\mu$ A Currents Measurement

To measure AC $\mu$ A current, set up the Meter as Figure 3-5 and proceed as follows:

1. Insert the red test lead into the  $\mu$ **A** terminal and black test lead into the **COM** terminal.
2. Set the rotary switch to  $\mu$ **A**  $\sim$ . DC measurement is default, press **SELECT** button to select AC measurement mode.
3. Connect the test leads in serial with the object being measured.  
The measured value shows on the display.  
It displays the True RMS value.
4. When a ACV function is selected, you can press the **AC+DC** button to view the AC + DC True RMS value in the primary display. To exit, please **EXIT** button.

## Model UT804: OPERATING MANUAL

### DCmA range measurement

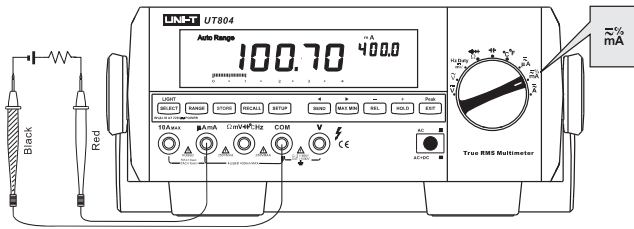

Figure 3-6. DCmA Currents Measurement

To measure DCmA current, set up the Meter as Figure 3-6 and proceed as follows:

1. Insert the red test lead into the  $\mu A$  mA terminal and black test lead into the **COM** terminal.
2. Set the rotary switch to **mA**. DC measurement is default, or press **SELECT** button to select DC measurement mode
3. Connect the test leads in serial with the object being measured.  
The measured value shows on the display. It displays the RMS.



### ACmA range measurement

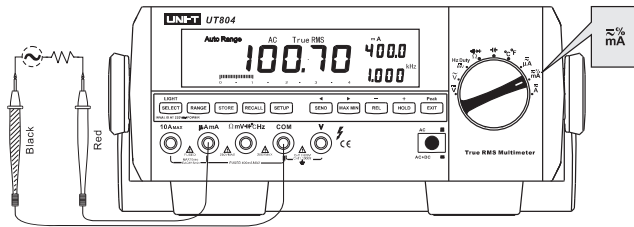

Figure 3-7. ACmA Currents Measurement

To measure ACmA current, set up the Meter as Figure 3-7 and proceed as follows:

1. Insert the red test lead into the  $\mu\text{AmA}$  terminal and black test lead into the **COM** terminal.
2. Set the rotary switch to **mA**  $\sim$ . DC measurement is default, press **SELECT** button to select AC measurement mode
3. Connect the test leads in serial with the object being measured.  
The measured value shows on the display.  
It displays the True RMS value.
4. When a ACV function is selected, you can press the **AC+DC** button to view the AC + DC True RMS value in the primary display. To exit, please **EXIT** button.

## Model UT804: OPERATING MANUAL

### DCA range measurement

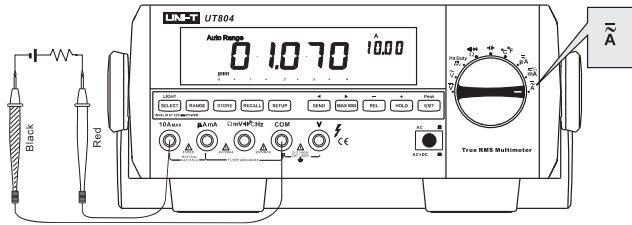

Figure 3-8. DCA Currents Measurement

To measure DCA current, set up the Meter as Figure 3-8 and proceed as follows:

1. Insert the red test lead into the **10A** terminal and black test lead into the **COM** terminal.
2. Set the rotary switch to **A**  $\sim$ . DC measurement is default, or press **SELECT** button to select DC measurement mode
3. Connect the test leads in serial with the object being measured.

The measured value shows on the display. It displays the RMS.

### ACA range measurement

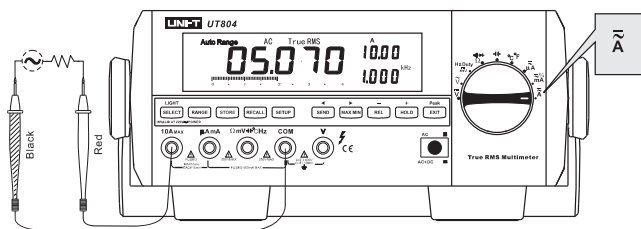

Figure 3-9. ACA Currents Measurement

To measure ACA current, set up the Meter as Figure 3-9 and proceed as follows:

1. Insert the red test lead into the **10A** terminal and black test lead into the **COM** terminal.
2. Set the rotary switch to **A**. DC measurement is default, press **SELECT** button to select AC measurement mode

3. Connect the test leads in serial with the object being measured.  
The measured value shows on the display.  
It displays the True RMS value.
4. When a ACV function is selected, you can press the **AC+DC** button to view the AC + DC True RMS value in the primary display.

### Note

- 1 If the value to be measured is unknown, use the maximum measurement position and reduce the range step by step until a satisfactory reading is obtained.
- 1 When the measured current is  $\leq 5A$ , continuous measurement is allowed.
- 1 When the measured current is between  $>5A-10A$ , continuous measurement  $\leq 10$  seconds and interval more than 15 minutes.
- 1 When current measurement has been completed, disconnect the connection between the testing leads and the circuit under test and remove testing leads away from the input terminals of the Meter.

### E. Measuring Resistance

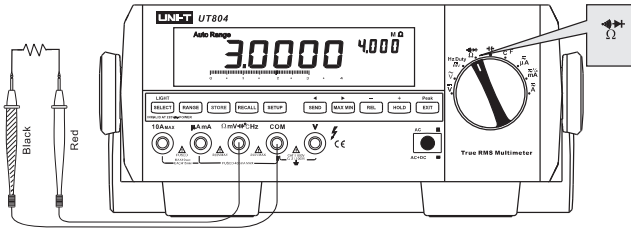



Figure 3-10. Resistance Measurement

#### Warning

To avoid harms to you, please do not attempt to input voltage higher than 60V DC or 30V AC.

To avoid possible damages to the Meter or to the devices under test, disconnect circuit power and discharge all the high-voltage capacitors before measuring resistance.

To measure resistance, set up the Meter as shown in Figure 3-10 and follow the following procedure:

1. Insert the red test lead into the  $\Omega$  terminal and the black test lead into the **COM** terminal.
2. Set the rotary switch to  $\Omega$    $\rightarrow$  ; press **SELECT** button to select  $\Omega$  measurement mode.
3. Connect the test leads across with the object being measured.

The measured value shows on the display.

The **SELECT** button cycles among resistance, continuity, and diode.

### Note

- 1 When measuring low resistance, the test leads can add  $0.1\Omega$  to  $0.2\Omega$  of error to resistance measurement. To test the leads, touch the probe tips together and read the resistance of the leads. If necessary, you can press **REL**  $\Delta$  to automatically subtract this value.
- 1 For high-resistance measurement ( $>1M\Omega$ ), it is normal taking several seconds to obtain a stable reading. In order to obtain precision readings, use the test lead as short as possible.
- 1 The LCD displays **OL** indicating open-circuit or the tested resistor value is higher than the maximum range of the Meter.
- 1 When testing the resistance signal from the calibrator, it is necessary to press and hold the **RANGE** while turning on the Meter to change the maximum display to 4000 counts but the accuracy remains unchanged.
- 1 When resistance measurement has been completed, disconnect the connection between the testing leads and the circuit under test and remove testing leads away from the input terminals.

### F. Testing for Continuity

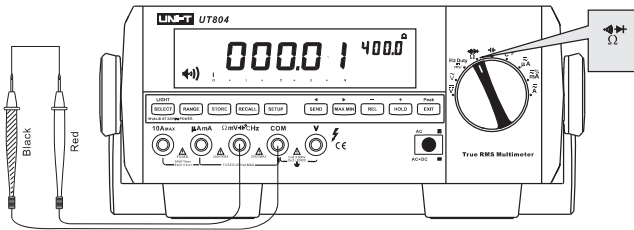





Figure 3-11. Continuity Test

#### Warning

To avoid harms to you, please do not attempt to input voltage higher than 60V DC or 30V AC.

To avoid possible damages to the Meter or to the devices under test, disconnect circuit power and discharge all the high-voltage capacitors before measuring continuity.

To test for continuity, set up the Meter as Figure 3-11 and do the following:

1. Insert the red test lead into the  $\Omega$  terminal and the black test lead into the **COM** terminal.
2. Set the rotary switch to  $\Omega$   ; press **SELECT** button to select  measurement mode and connect the test leads across with the object being tested.
3. The beeper comes on continuously for open conditions, that is test resistance around  $< 50\Omega$ .
4. The display shows the tested resistance load value. The unit is  $\Omega$ .

The **SELECT** button cycles among resistance, continuity, and diode.

#### Note

- 1 Open circuit voltage around  $-1.2V$  and range is  $400\Omega$  measurement range.
- 1 When continuity testing has been completed, disconnect the connection between the testing leads and the circuit under test and remove the test leads away from the input terminals.

### G. Testing Diodes

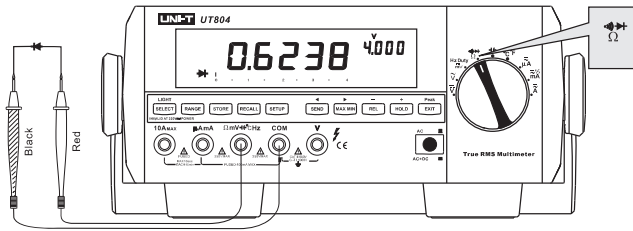

Figure 3-12. Diode Test

#### **⚠ Warning**

To avoid harms to you, please do not attempt to input voltages higher than 60V DC or 30V AC.

To avoid damages to the Meter or to the devices under test, disconnect circuit power and discharge all the high-voltage capacitors before testing diodes.

Use the diode test to check diodes, transistors, and other semiconductor devices. The diode test sends a current through the semiconductor junction, then measure the voltage drop across the junction. A good silicon junction drops between 0.5V and 0.8V

To test the diode out of a circuit, set up the Meter as Figure 3-12 and proceed as follows:

1. Insert the red test lead into the  $\Omega$  terminal and the black test lead into the **COM** terminal.
2. Set the rotary switch to  $\Omega \cdot \text{diode symbol}$ ; and press button to select  $\text{diode symbol}$  measurement mode.
3. For forward voltage drop readings on any semiconductor component, place the red test lead

## Model UT804: OPERATING MANUAL

on the component's anode and place the black test lead on the component's cathode. The red test lead polarity is "+" while the black test lead polarity is "—". The measured value shows on the display.

The **SELECT** button cycles among resistance, continuity, and diode.

### Note

- 1 In a circuit, a good diode should still produce a forward voltage drop reading of 0.5V to 0.8V; however, the reverse voltage drop reading can vary depending on the resistance of other pathways between the probe tips.
- 1 Connect the test leads to the proper terminals as said above to avoid error display.
- 1 The LCD will display **OL** indicating either open circuit or wrong polarity connection.
- 1 The unit of diode is volt (V), displaying the positive-connection voltage-drop value.
- 1 Open circuit voltage approximate 2.8V.
- 1 When diode testing has been completed, disconnect

the connection between the testing leads and the circuit under test and remove the test leads away from the input terminals.



### H. Measuring Capacitance

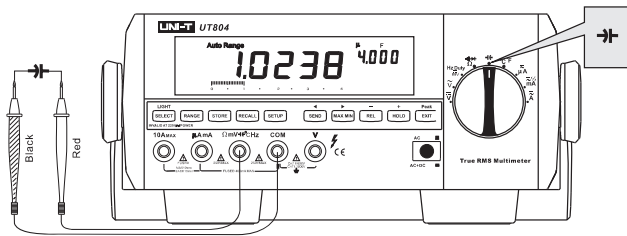

Figure 3-13. Capacitance Measurement

### ⚠ Warning

To ensure accuracy, the Meter inside is discharged against the tested capacitor. “----” will be shown on the display when it is under discharging, this process will be quite slow.

To avoid damage to the Meter or to the equipment under test, disconnect circuit power and discharge all high-voltage capacitors before measuring capacitance.

To measure capacitance, set up the Meter as shown in Figure 3 -13 and proceed as follows:

1. Insert the red test lead into the **C** terminal and the black test lead into the **COM** terminal.
2. Set the rotary switch to **C** measurement mode, the Meter may display a fixed reading which is a internal distributed capacitor value. For testing less than 10nF capacitor, the tested value must subtract the3. It is recommended to use test clip to carry out measurement to reduce the effect of internal distributed.

## Model UT804: OPERATING MANUAL

accuracy.

To improve the measurement accuracy of small value capacitors (less than 10nF), press **REL Δ** with the test leads open to subtract the residual capacitance of the Meter and leads.

3. It is recommended to use test clip to carry out measurement to reduce the effect of internal distributed capacitor.

### Note

- 1 The LCD displays **OL** indicating the tested capacitor is shorted or it exceeds the maximum range.
- 1 Capacitors larger than 400 $\mu$ F take longer time. The analogue bar graph shows the time left before finishing the measurement.
- 1 When capacitance measurement has been completed, disconnect the connection between the testing leads and the circuit under test and remove the test leads away from the input terminals of the Meter.

### I. Measuring Frequency / Duty Cycle

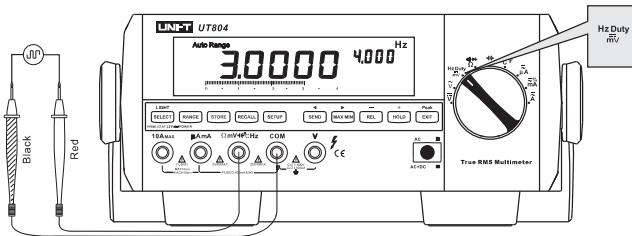

Figure 3-14. Frequency / Duty Cycle Measurement

#### Warning

To avoid harms to you, please do not attempt to input tested frequency voltage higher than 30V rms.

To measure frequency and duty cycle, connect the Meter as Figure 3-14 and do the following:

1. Insert the red test lead into the **Hz** terminal and the black test lead into the **COM** terminal.
2. Set the rotary switch to  $\frac{\text{Hz}}{\text{mV}}$  and press **SELECT** button to select the Hz measurement mode for frequency measurement or % for duty cycle measurement.  
The **SELECT** button cycles among  $\text{mV}$ , frequency and duty cycle.
3. Connect the test leads across with the object being measured.  
The measured value shows on the primary display.

#### Note

- 1 The requirement of Input amplitude “a” is as follows:  
When 10Hz~40MHz:  $200 \text{ mV} \leq a \leq 30\text{Vrms}$ ;  
>40MHz: Un-specified
- 1 When Hz or Duty Cycle measurement has been completed, disconnect the connection between the testing leads and the circuit under test and remove the test leads away from the input terminals.

### J. Measuring Temperature

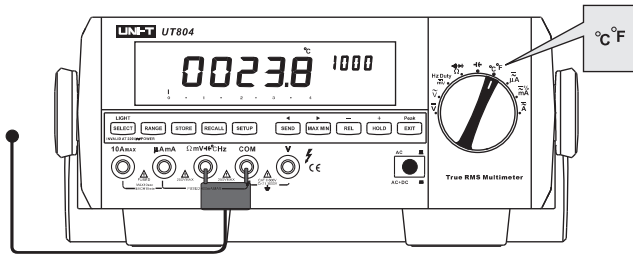

Figure 3-15. Temperature Measurement

#### Warning

**To avoid harms to you, please do not attempt to input voltages higher than 60V DC or 30V AC.**

To measure temperature, set up the Meter as shown in Figure 3-15 and proceed the following.

1. Set the rotary switch to °C °F , the display shows **OL**. Short circuit the test leads to show the room temperature.
2. Insert the point contact temperature probe into the Meter as figure 10.
3. Place the temperature probe to the object being measured.  
The measured value shows on the display after several seconds.
4. The Meter is default to Celsius °C degree unit, you can change units by press the **SELECT** button once you have selected the temperature function.

#### Note

- 1 Place the Meter in an environment of 18°C~28°C otherwise false reading may be obtained especially in testing low temperature.
- 1 The included point contact temperature probe can only be used with temperature 230°C below.
- 1 When temperature measurement has been completed, disconnect the connection between the testing leads and the circuit under test and remove the test leads away from the input terminals.

### K. 4~20 mA loop current as % readout

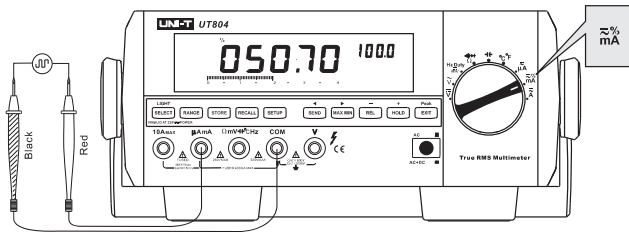

Figure 3-16. 4~20mA loop current as % readout

### ⚠ Warning

To avoid electric shock, please take extra care during measurement.

To avoid harms to the Meter and yourself, never input higher than 250V from socket, although readings may be obtained.

Before the Meter and the tested object are connected to the to be tested return circuit, turn the return circuit power off.

It shows the mA measured value or output level in %, in a 4-20mA scale

To use 4~20mA Loop feature, connect the Meter as follows:

1. Set the rotary switch to  $\overline{\text{mA}} \%$ , and press **SELECT** button to select (**4~20mA**) % feature.
2. The rest procedure, please follow D. Measuring Current: DC current measurement.

### 3. When the readings obtained is:

- 1 < 4mA, the primary display shows LO
- 1 4mA, the primary display shows 0%. ....
- 1 20mA, the primary display shows 100%
- 1 > 20mA, the primary display shows HI

### Note

- 1 When the measured current is  $\leq 5A$ , continuous measurement is allowed.
- 1 When the measured current is between 5A-10A, continuous measurement  $\leq 10$  seconds and interval more than 15 minutes.
- 1 Do not attempt to measure higher than 10A.
- 1 When measurement has been completed, disconnect the connection between the testing leads and the circuit under test and remove the test leads away from the input terminals.

## Chapter 4

### Using Store, Recall & Send Features

#### Introduction

Chapter 4 shows you how to use stores, recall and communication features available on the Meter

#### Store and Clearing Readings

To store readings, proceed as follows:

- 1 Press **STORE** once, “STORE” and “No.xxxx” appears to confirm the operation and the upper right secondary display shows the current measurement reading. Press **▶** to toggle between clearing the stored readings and start from the first readings or start from the last stored reading. Lower right secondary display shows the original number of records.
- 1 Press **STORE** the second time, “STORE” and “s” appears. The upper right secondary display shows the storing time interval in second, it is preset to zero which means it will not auto update reading. To change the interval in second by pressing **+** or

- button. The interval can be as high as 255 seconds or as low as 0 second. Press and hold **+** or **-** to access the quick setting.

- 1 Press **STORE** the third time, “STORE” and “No. 9999” appears. The upper right secondary display shows the index number increase one. The lower right secondary display shows the value of the corresponding index number, the primary display shows the current measurement reading.
- 1 If there is no set time to store the reading, each press of **STORE** to store one reading. An index number increase one.
- 1 The maximum number of stored reading is 9999. When the stored readings memory is full, the Meter will stop storing data.
- 1 To exit and stored the reading, press **EXIT**.
- 1 To exit without storing the reading, turn the Meter off directly.
- 1 Automatic power off feature will be disabled after entering this mode.

### Recalling Stored Readings

Use the following procedure to recall the stored reading:

- 1 Press **RECALL** to recall the stored value and RECALL appears to confirm the operation.
- 1 The upper right secondary display shows the index number "No.xxxx".
- 1 The primary display shows the corresponding recalled data.
- 1 The lower right secondary display shows the total number of the stored data.
- 1 Press ► button to enable the SEND feature to export the data to the computer via USB or RS232. The software shows the data storing time and also the data value. After the data transferring is completed, the SEND feature will be disabled automatically.
- 1 Press + or - button to view additional stored reading.  
Press and hold + or - to access quick recalling.
- 1 Press **EXIT** to exit recalling.

### Using Send

When using a Send feature, please refer to the Installation Guide of the included CD-ROM. It is possible to use RS232 or USB interface cable to connect between computer and the Meter.



## Chapter 5 Changing the Default Setting

### Introduction

The Meter allows you to change the default operating configuration of the Meter by changing setup options made at the factory.

These settings are stored and can be changed in the Setup mode using the procedure described in this chapter.





### Selecting Setup Options

To enter the Setup mode, turn the Meter on and press the **SETUP** button. It is recommended to change the default setting only when the Meter is at DCV measurement mode.

In the Setup mode, each press of **SETUP** button steps to the next Selection. Each press of **-** or **+** button decrement or increment an Option.

Each Setup Selection and Option appears in the primary display in the sequence shown in Table 5-1.

Table 5-1. Setup Selections

Selection	Option	Factory Default	Description
HIGH	Max. 40000 Press ► to select OFF Press ◀ to select the digit you want to edit	OFF	Over the upper limits, beeps not continuously.
LOW	Max. 40000 Press ► to select OFF Press ◀ to select the digit you want to edit	OFF	Over the lower limits, beeps not continuously.
	10	10 mins	10 mins power off
	20		20 mins power off
	30		30 mins power off
	OFF		Power off feature is disabled
	1	S1	Beeps continuously and icon lights on
	OFF		No beep, icon flashes
	10	10	Backlight turn off in 10 seconds
	20		Backlight turn off in 20 seconds
	30		Backlight turn off in 30 seconds
	OFF		Disable backlight feature.
Analogue Bar Graph	Zero is in the left hand side.	Zero is in the left hand side	
	Zero is in the center		
			It can only apply to DCV and DCI functions.

## **Saving Setup Options**

At each setup Option, store your choice and exit setup by press **EXIT**, advance to the next Option by press **+**.

To exit the Setup mode without saving the present Option, press **Setup**.

## Chapter 6 Maintenance

This chapter provides basic maintenance information including battery and fuse replacement instruction.

### Warning

**Do not attempt to repair or service your Meter unless you are qualified to do so and have the relevant calibration, performance test, and service information.**

#### A. General Service

- 1 Periodically wipe the case with a damp cloth and mild detergent. Do not use abrasives or solvents.
- 1 To clean the terminals with cotton bar with detergent, as dirt or moisture in the terminals can affect readings.
- 1 Turn the Meter to OFF when it is not in use.
- 1 Take out the battery when it is not using for a long time.
- 1 Do not use or store the Meter in a place of humidity, high temperature, explosive, inflammable and strong magnetic field.

#### B. Replacing the Fuses

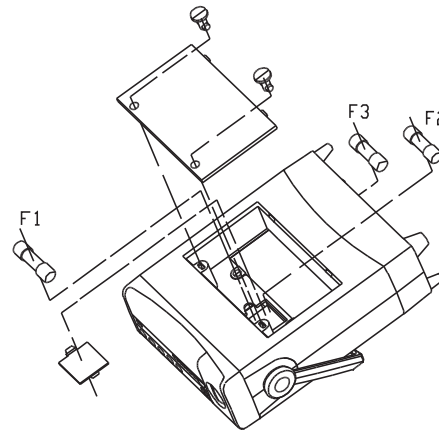

Figure 6-1. Fuse Replacement

### Warning

**To avoid electrical shock or arc blast, or personal injury or damage to the Meter, use specified fuses ONLY in accordance with the following procedure.**

Follow Figure 6-1 and proceed as follows to replace the Meter's fuse:

- 1 Switch off the Meter, disconnect the power cord and remove all connections from the terminals.
- 1 Remove the fuse cover from the power socket at the Meter's back, then remove the Fuse 3 by gently prying one end loose, then take out from its bracket.
- 1 Use the coin to open the compartment at the case top, then remove the Fuse 1 and 2 by gently prying one end loose, then take out from its bracket.
- 1 Install ONLY replacement fuses with the identical type and specification as follows and make sure the fuse is fixed firmly in the bracket.
  - Fuse 1: 0.5A, 250V, fast type fuse,  $\varnothing 5 \times 20$ mm
  - Fuse 2: 10A, 250V, fast type fuse,  $\varnothing 5 \times 20$ mm
  - Fuse 3: 0.5A, 125V, fast type fuse,  $\varnothing 5 \times 20$ mm

- 1 Rejoin the fuse cover and the power socket.
- 1 Rejoin the compartment and the case top and close the compartment.

Replacement of the fuses is seldom required. Burning of a fuse always results from improper operation.

## C. Replacing the Battery

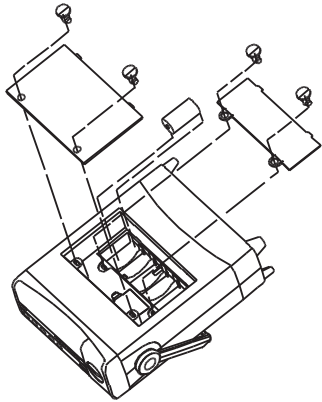



Figure 6-2. Battery Replacement

### Warning

To avoid false readings, which could lead to possible electric shock or personal injury, replace the battery as soon as the battery indicator “” appears when the Meter is under battery operated situation. When the Meter is under battery operated situation, battery cannot be re-charged.

**Make sure the test leads are disconnected from the circuit being tested before opening the case bottom.**

Follow Figure 6-2 and proceed as follows to replace the battery:

- 1 Switch off the Meter, disconnect the power cord and remove all connections from the terminals.
- 1 Use the coin to open the compartment at the case top, and separate the compartment from the case top.
- 1 Replace with 6 pieces 1.5V battery.
- 1 Rejoin the case top and compartment and close the compartment.

## Chapter 7 Specifications

### Safety and Compliances

Maximum Voltage between any Terminal and Grounding	Refer to different range input protection voltage
Certification	CE
Compliances	IEC 61010 CAT.I 1000V, CAT.II 600V overvoltage and double insulation standard
⚠ Fused Protection for $\mu$ <b>AmA</b> input terminal:	0.5A, 250V, fast type fuse, $\varnothing$ 5x20mm
⚠ Fused Protection for <b>A</b> input terminal:	10A , 250V,fast type fuse, $\varnothing$ 5x20mm
⚠ Fused Protection for power socket:	0.2A, 250V, fast type fuse, $\varnothing$ 5x20m

## Physical Specifications

Display (LCD)	Digital: 40000 counts on primary display; updates 2-3 times / second. 4000 counts on secondary display. Analog: 40 segments; updates 10 times / second.
Operating Temperature	0°C~40°C (32°F~104°F)
Storage Temperature	0°C~40°C (32°F~104°F)
Relative Humidity	≤75% @ 0°C~30°C below; ≤50% @ 30°C~40°C:
Altitude	This Meter can be used in indoor and altitude not more than 2000M.
Power	Battery Type: 6pcs x 1.5V battery (R14). AC 200V ~240V 50Hz
Electromagnetic Compatibility	I In a radio field of 1 V/m below: Overall Accuracy = Specified Accuracy + 5% of Range I In a radio field of 1 V/m above: No assigned accuracy is specified.
Dimensions (H x W x L)	105 x 240 x 310 mm.
Weight	Approx.3kg (including battery)



### General Specifications

Range	Auto
Polarity	Auto
Overloading	Display <b>OL</b> (except at 4~20mA Loop range which display <b>HI</b> or <b>LO</b> )
Battery Deficiency	Display 

### Feature Summary

Tri Displays	Primary: 40,000 counts Left Secondary: 4000 counts. Right Secondary: 4000 counts
Analogue Bar Graph	Bar Graph: 40 segments, updates 10 times / second
Backlight	Bright backlight for clear readings in poorly lighted areas.
Autorange	The Meter automatically selects best range
AC+DC True RMS, AC RMS	Choices for AC only or AC+DC readings
Data Hold	Holds readings on display
Continuity	Beeper sounds for resistance readings below threshold.
Bar Graph	40 segments
Duty Cycle	Measure signal on or off time in %.
MAX MIN Mode	Record maximum and minimum
Battery Access Door	Battery replaceable.

### Basic Specifications

Function	Ranges / Description
DC Voltage	0 to 1000V
AC Voltage, True RMS	0 to 1000V, 100kHz bandwidth
Basic Accuracy	DC Voltage: 0.025% AC Voltage: 0.4%
DC Current	0 to 10A (5~10A for $\leq 10$ seconds, interval $\geq 15$ minutes)
AC Current, True RMS	0 to 10A (5~10A for $\leq 10$ seconds, interval $\geq 15$ minutes)
Resistance	0 to 40M $\Omega$
Capacitance	0 to 40mF
Frequency	0~400MHz
Temperature	-40°C~1000°C (-40°F~1832°F)
STORE Readings	Up to 9999 readings may be saved by the user in a memory. These readings may be viewed by using Recall feature.

### Detailed Accuracy Specifications

Accuracy:  $\pm$  ( [% of reading] + [number of least significant digits] ), guarantee for 1 year.

Operating temperature: 18°C~28°C

Relative humidity:  $\leq$ 75%RH

#### A. DC Voltage

Range	Resolution	Accuracy	Overload Protection	Input Impedance
400mV	0.01mV	$\pm$ (0.025%+5) under REL mode	1000V	Around 2.5G $\Omega$
4V	0.0001V	$\pm$ (0.05%+5)		Around 10M $\Omega$
40V	0.001V			
400V	0.01V			
1000V	0.1V			

**B. AC Voltage (AC+DC measurement is available)**

Range	Resolution	Bandwidth	Accuracy
4V	0.0001V	45Hz~1kHz	± (0.4%+30)
		>1kHz~10kHz	± (1.5%+30)
		>10kHz~100kHz	± (6%+30)
40V	0.001V	45Hz~1kHz	± (0.4%+30)
		>1kHz~10kHz	± (1.5%+30)
		>10kHz~100kHz	± (6%+30)
400V	0.01V	45Hz~1kHz	± (0.4%+30)
		>1kHz~10kHz	± (5%+30)
		>10kHz~100kHz	Not Specified
1000V	0.1V	45Hz~1kHz	± (1%+30)
		>1kHz~5kHz	± (5%+30)
		>5kHz~10kHz	± (10%+30)

**Remarks:**

- 1 Input Impedance: Approx 10MΩ
- 1 Overload Protection: 1000V.
- 1 Display:

- a) True rms are valid from 10% of range to 100% of range
- b) AC crest factor can be up to 3.0 except 1000V where it is 1.5.
- c) A residual reading of 80 digits with test leads shorted, will not affect stated accuracy.
- d) The accuracy guarantee range 10%-100%.
- e) When making AC+DC measurement, the accuracy need to add (1%+ 35 digits) of reading based on the above table.

### C. DC Current

Range	Resolution	Bandwidth	Accuracy
400μA	0.01μA	± (0.1%+15)	0.5A, 250V, fast type fuse, ø5x20mm
4000μA	0.1μA		
40mA	0.001mA	± (0.15%+15)	
400mA	0.01mA		
10A	0.001A	± (0.5%+30)	10A, 250V, fast type fuse, ø5x20mm

#### Remarks:

##### At 10A range:

- 1 When the measured current is ≤5A, continuous measurement is allowed.
- 1 When the measured current is between >5A-10A, continuous measurement ≤10 seconds and interval more than 15 minutes.

## D. AC Current (AC+DC measurement is available)

Range	Resolution	Bandwidth	Accuracy	Overload Protection
400μA	0.01μA	45Hz~1kHz	± (0.7%+15)	0.5A, 250V, fast type fuse, ø5x20mm
4000μA	0.1μA	>1kHz~5kHz	± (1%+30)	
40mA	0.001mA	>5kHz~10kHz	± (2%+40)	
400mA	0.01mA			
10A	0.001A	45Hz~1kHz	± (1.5%+40)	10A, 250V, fast type fuse, ø5x20mm
		>1kHz~ 5kHz	± (2.5%+40)	
		>5kHz~10kHz	± (5%+40)	

### Remarks:

#### 1 Display:

- a) True rms are valid from 10% of range to 100% of range
- b) AC crest factor can be up to 3.0.
- c) A residual reading of 80 digits with test leads shorted, will not affect stated accuracy.
- d) The accuracy guarantee range 10%-100%.
- e) When making AC+DC measurement, the accuracy need to add(1%+35 digits)of reading based on the above table.

#### 1 At 10A range:

- a) When the measured current is  $\leq 5A$ , continuous measurement is allowed.
- b) When the measured current is between  $>5A-10A$ , continuous measurement  $\leq 10$  seconds and interval more than 15 minutes.

## E. Resistance

Range	Resolution	Accuracy	Overload Protection
400Ω	0.01Ω	± (0.3%+40)+test leads open circuit value	1000V
4kΩ	0.0001kΩ	± (0.3%+40)	
40kΩ	0.001kΩ		
400kΩ	0.01kΩ	± (0.5%+40)	
4MΩ	0.0001MΩ	± (1%+40)	
40MΩ	0.001MΩ	± (1.5%+40)	

## F. Continuity Test

Range	Resolution	Overload Protection
• )	0.01Ω	1000V

### Remarks:

- 1 Open circuit voltage approximate 1.2V.
- 1 The buzzer does not sound when the test resistance is >50Ω.
- 1 The beeper comes on continuously for open conditions, that is test resistance is ≤10Ω.

## G. Diode Test

Range	Resolution	Overload Protection
→	0.0001V	1000V

### Remarks:

- I Open circuit voltage approximate 2.8V.
- I A good silicon junction drops between 0.5V and 0.8V.

## H. Capacitance

Range	Resolution	Accuracy	Overload Protection
40nF	0.001nF	$\pm (1\%+20)$ + capacitance value of open circuit test leads	1000V
400nF	0.01nF	$\pm (1\%+20)$	
4 $\mu$ F	0.0001 $\mu$ F		
40 $\mu$ F	0.001 $\mu$ F		
400 $\mu$ F	0.01 $\mu$ F	$\pm (1.2\%+20)$	
4mF	0.0001mF	$\pm (5\%+20)$	
40mF	0.001mF	Not specified	



## I. Frequency

Range	Resolution	Accuracy	Overload Protection
40Hz	0.001Hz	± (0.01%+8)	1000V
400Hz	0.01Hz		
4kHz	0.0001kHz		
40kHz	0.001kHz		
400kHz	0.01kHz		
4MHz	0.0001MHz		
40MHz	0.001MHz		
400MHz	0.01MHz	Not Specified	

### Remarks:

1 Input amplitude "a" as follows; (DC electric level is zero)

When 10Hz~40MHz :  $200\text{mV} \leq a \leq 30\text{Vrms}$ ;

When >40MHz : Not specified

## Model UT804: OPERATING MANUAL

### J. Duty Cycle

Range	Resolution	Accuracy	Overload Protection
100%	0.01%	± (0.01%+40)	1000V

#### Remarks:

- 1 It is valid from 10% of range to 90% of range.
- 1 Input amplitude “a” as follows; (DC electric level is zero)
  - When 10Hz~40MHz :  $200\text{mV} \leq a \leq 30\text{Vrms}$ ;
  - When >40MHz : Not specified

### K. Temperature

#### 1-1. Degrees Celsius

Range	Resolution	Accuracy	Overload Protection
-40°C~40°C	0.1°C	± (3%+30)	1000V
40°C~400°C		± (1%+30)	
400°C~1000°C		± 2.5%	

### 1-2. Fahrenheit

Range	Resolution	Accuracy	Overload Protection
-40°F~32°F	0.1 °F	± (4%+50)	1000V
32°F~752°F		± (1.5%+50)	
752°F~1832°F		± 3%	

#### Remarks:

- 1 Included is a K-Type (nickel chromium~nickel silicon) point contact temperature probe which could only measure temperature below 230°C. If you want to measure temperature higher than 230°C, you must use the rod contact temperature probe.

### L. 4~20 mA loop current

Range	Resolution	Accuracy	Overload Protection
(4~20mA)%	0.01%	± (1%+50)	0.5A, 250V, fast type fuse, ø5x20mm

#### Remarks:

When the readings obtained is:

- 1 < 4mA, the primary display shows LO
- 1 4mA, the primary display shows 0% .... 20mA, the primary display shows 100%
- 1 > 20mA, the primary display shows HI

**\*\* END \*\***

This operating manual is subject to change without notice.

©Copyright 2006 Uni-Trend Group Limited.  
All rights reserved.

Manufacturer:  
Uni-Trend Technology (Dongguan) Limited  
Dong Fang Da Dao  
Bei Shan Dong Fang Industrial Development District  
Hu Men Town, Dongguan City  
Guang Dong Province  
China  
Postal Code: 523 925

Headquarters:  
Uni-Trend Group Limited  
Rm901, 9/F, Nanyang Plaza  
57 Hung To Road  
Kwun Tong  
Kowloon, Hong Kong  
Tel: (852) 2950 9168  
Fax: (852) 2950 9303  
Email: [info@uni-trend.com](mailto:info@uni-trend.com)  
<http://www.uni-trend.com>